



Technical  
Information



*find your way*



Leit- und Orientierungssysteme vermitteln einen ersten - oft entscheidenden - Eindruck und sind wichtiger Ausdruck der Kundenfreundlichkeit. Abgestimmt auf die Architektur und die spezifischen Anforderungen des Gebäudes sind sie wesentlicher Bestandteil der Corporate Identity und spiegeln - hochwertig, durchdacht, konsequent in Form und Funktion - Selbstverständnis und Identität eines Unternehmens, einer Institution oder einer Behörde wider. Erst durch viele funktionale und gestalterische Details und hohe Qualitätsstandards wird aus einem Wegweiser oder Schild ein ausgereiftes Orientierungs- und Leitsystem. Bei der Entwicklung der Orientierungs- und Leitsysteme berücksichtigt moedel konsequent die hohen Anforderungen von Planern und Kunden. In die Entwicklung und Herstellung der unterschiedlichen Systeme fließt die über 30-jährige Erfahrung in der Produktion von Siebdruckerzeugnissen ein. 90 qualifizierte Mitarbeiterinnen und Mitarbeiter erarbeiten auf 2 Werksgeländen mit insgesamt 15.000 m<sup>2</sup> nahe Amberg nach zertifizierten Fertigungsabläufen (DIN EN ISO 9001) Produkte von höchster Präzision, Perfektion und Beständigkeit.

*Information and orientation systems often provide that all-important first impression while giving vital expressions of customer-friendliness at the same time. Carefully coordinated with the architecture and the specific requirements of the building they form an essential part of corporate identity, reflecting the image and identity of the company, institution or public authority. High quality, well conceived and rigorous in both form and function. It takes great attention to functional and design details, along with high quality standards, to turn a sign or guide into an optimized information and orientation system, moedel rigorously meets the high requirements of planners and customers in the development of information and orientation systems, drawing on over 30 years of experience in the production of screen print products to develop and produce a diversity of systems. A team of 90 employees work at two factory premises (together 15.000 m<sup>2</sup>) near Amberg, where certified production processes (DIN EN ISO 9001) turn out products of the highest precision, perfection and durability.*

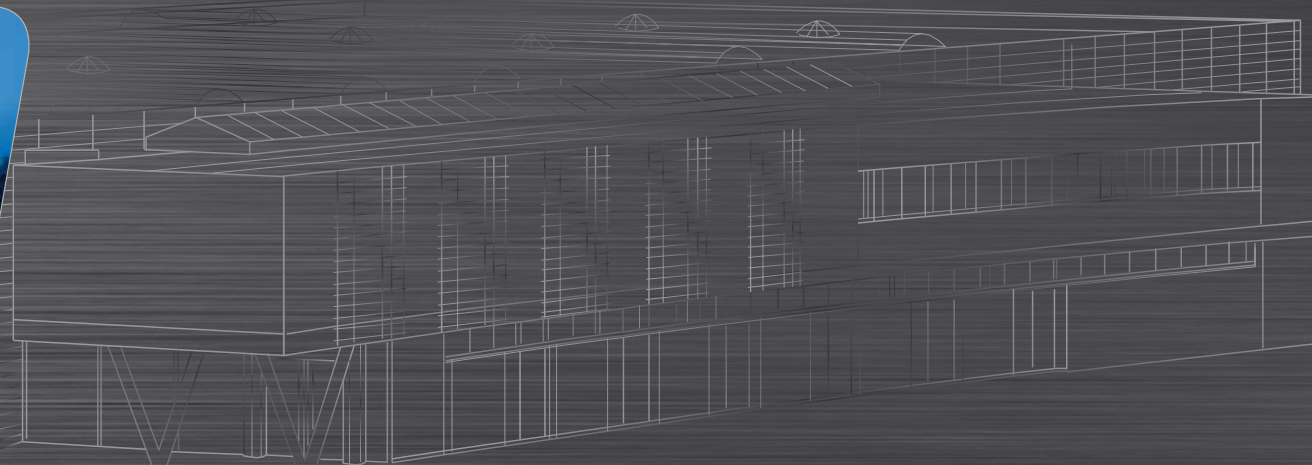

## Madrid Black Line Outdoor stands

**NEW**

A charming welcome – the Madrid outdoor stand from the "Black Line" represents zeitgeist and taste.

### Technical data:

The base body consists of black-anodized aluminium frame, which is cut to mitre and connected with angles in the inside. Additional connecting profiles in the inside arrange the necessary stability and serve the sign panel made of composite aluminium in RAL 9005 (matt) as enforcement. The overall depth is 80 mm. The standard means of installation is on side posts lengthened by 500 mm (steel 60 x 60 mm). Information about foundation plan and statics can be found on page 96.

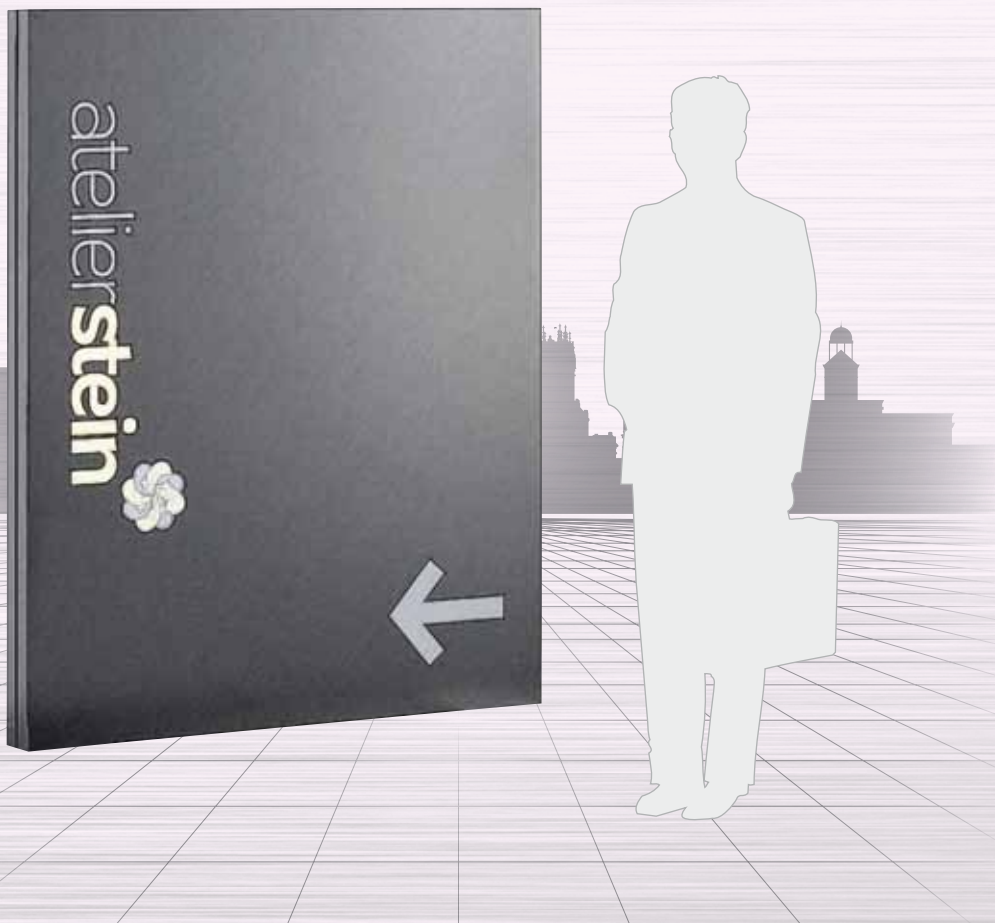

Sign size	Information area	Art. No.		
height x width x depth in mm	height x width in mm			
<b>portrait</b>				
2000 x 730 x 80	1997,5 x 725,5	i 25outdoor2000.730f17		
2500 x 1000 x 80	2497,5 x 995,5	i 25outdoor2500.1000f17		
3000 x 1250 x 80	2997,5 x 1245,5	i 25outdoor3000.1250f17		
<b>landscape</b>				
1250 x 1800 x 80	1247,5 x 1795,5	i 25outdoor1250.1800f17		

Accessories	width x depth x height	Art. No.		
	in mm			
Base plate (steel)	250 x 250 x 10	i 25bopla		

Special sizes on request.

## Madrid Ground-mounted spotlights

**NEW**

For outdoor use, incl. illuminant. Please have a look on page 90 for detailed information.

Name	visible format	installation depth	up to the height of	output	Art. No.	
	in mm	in mm				
swivelling floodlights „circle 1“	Ø 215	225	2 m	75 W	i leucht1	
asymmetrical floodlights „circle 2“	Ø 265	220	3 m	70 W	i leucht2	
asymmetrical floodlights „square“	120 x 1000	110	2 m	21 W	i leucht3	
swivelling ground spotlight „flexi“	Ø 250	-	2,5 m	70 W	i leucht4	
spike for the spotlight	l 250	250	-	-	i spieß	



## Madrid Black Line Indoor stands

**NEW**

Consistent understatement – this is the impression that the Madrid indoor stand from the “Black Line” leaves. The sign information can be applied flexibly on both sides by means of graphic text or paper with fitted exchanger modules\*.

### Technical data:

The base body consists of silver-anodized aluminium frame, which is cut to mitre and connected with angles in the inside. Justified composite aluminium panels (3 mm) in black RAL 9005 (matt) serve double-sided as sign panels. For mobile application we supply base plates (350 x 120 x 6 mm in RAL 9005), which are screwed edge to edge. The overall depth is 45 mm.



Sign size *	Information area	Art. No.		
height x width x depth in mm	height x width in mm			
1800 x 450 x 45	1795,5 x 445,5	i 25stele1800.450f17		
2000 x 600 x 45	1995,5 x 595,5	i 25stele2000.600f17		
2000 x 730 x 45	1995,5 x 725,5	i 25stele2000.730f17		

\* We require a scale assembly drawing of the proposed free standing. Please note that the door signs/directories must be capable of being opened towards the side or the top to enable the sign information to be changed.

Special sizes on request.

## Madrid Black Line Door Sign / Directory for wall mounting

Our special edition in black.

The frame consists of black anodized aluminium, the back panel is made of steel sheet in RAL 9006 as standard.

**NEW**

Sign size *	Information area	Art. No.		
height x width in mm	height x width in mm			
150,5 x 150,5 (Door sign 150)	144 x 144	i 2500f17		
299,5 x 212,5 (DIN A4)	293 x 206	i 2504f17		
422,5 x 299,5 (DIN A3)	416 x 293	i 2503f17		

\* Opening on the short side (leg); the sign can be mounted lengthways or sideways.

Special sizes on request.



## Madrid Gold Line Door Sign / Directory for wall mounting

Our special golden edition.

The frame consists of golden anodized aluminium, the back panel is made of steel sheet in RAL 9006.



Sign size *	Information area	Art. No.		
height x width in mm	height x width in mm			
105,5 x 105,5 (Door sign 105)	99 x 99	i 2511f19		
150,5 x 150,5 (Door sign 150)	144 x 144	i 2500f19		
299,5 x 212,5 (DIN A4)	293 x 206	i 2504f19		
422,5 x 299,5 (DIN A3)	416 x 293	i 2503f19		

\* Opening on the short side (leg); the sign can be mounted lengthways or sideways.

Special sizes on request.

## Madrid Black Line Door Sign / Directory for wall mounting

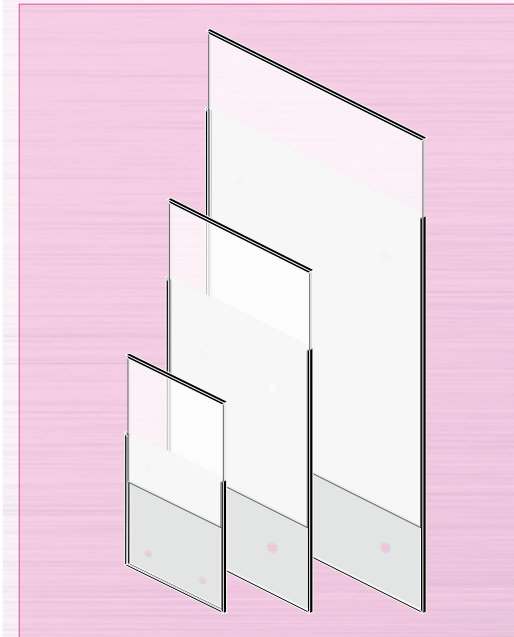

## Madrid Gold Line Door Sign / Directory for wall mounting

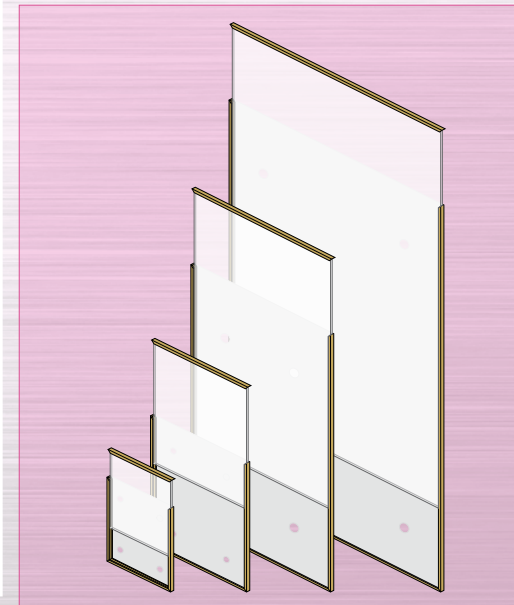

## Madrid Outdoor stands

Upright and gallant is the lasting first impression that the Madrid outdoor stand leaves.

### Technical data:

The base body consists of silver-anodized aluminium frame, which is cut to mitre and connected with angles in the inside. Additional connecting profiles in the inside arrange the necessary stability and serve the sign panel made of composite aluminium in silver RAL 9006 as enforcement. The overall depth is 80 mm.

The standard means of installation is on side posts lengthened by 500 mm (steel 60 x 60 mm).

Information about the foundation plan and structural calculations can be found on page 96.



Sign size	Information area	Art. No.		
height x width x depth in mm	height x width in mm			
<b>portrait</b>				
2000 x 730 x 80	1997,5 x 725,5	i 25outdoor2000.730		
2500 x 730 x 80	2497,5 x 725,5	i 25outdoor2500.730		
3000 x 730 x 80	2997,5 x 725,5	i 25outdoor3000.730		
2000 x 1000 x 80	1997,5 x 995,5	i 25outdoor2000.1000		
2500 x 1000 x 80	2497,5 x 995,5	i 25outdoor2500.1000		
3000 x 1000 x 80	2997,5 x 995,5	i 25outdoor3000.1000		
2000 x 1250 x 80	1997,5 x 1245,5	i 25outdoor2000.1250		
2500 x 1250 x 80	2497,5 x 1245,5	i 25outdoor2500.1250		
3000 x 1250 x 80	2997,5 x 1245,5	i 25outdoor3000.1250		
3750 x 1250 x 80 *	3747,5 x 1245,5	i 25outdoor3750.1250		
<b>landscape</b>				
1250 x 1800 x 80	1247,5 x 1795,5	i 25outdoor1250.1800		
1250 x 2000 x 80	1247,5 x 1995,5	i 25outdoor1250.2000		
1250 x 2500 x 80	1247,5 x 2495,5	i 25outdoor1250.2500		
1250 x 3000 x 80	1247,5 x 2995,5	i 25outdoor1250.3000		

Accessories	width x depth x height	Art. No.		
	in mm			
Base plate (steel)	250 x 250 x 10	i 25bopla		

\* Lettering area is separated.

## Madrid Ground-mounted spotlights

**NEW**



For outdoor use, incl. Illuminant. Please have a look on page 90 for detailed information.

Name	visible format	installation depth	up to the height of	output	Art. No.		
	in mm	in mm					
swivel-mounted ground spot „circle 1“	Ø 215	225	2 m	75 W	i leucht1		
asymmetrical ground spot „Circle 2“	Ø 265	220	3 m	70 W	i leucht2		
asymmetrical ground spot „Square“	120 x 1000	110	2 m	21 W	i leucht3		
swivel-mounted ground spot „Flexi“	Ø 250	-	2,5 m	70 W	i leucht4		
spike for the spotlight	l 250	250	-	-	i spieß		



## Madrid Indoor stands

Versatile and mobile is how the Madrid indoor stand presents itself. The sign information can be applied flexibly on both sides by means of graphic text or paper with fitted exchanger modules\*.

### Technical data:

The base body consists of silver-anodized aluminium frame, which is cut to mitre and connected with angles in the inside. Justified composite aluminium panels (3 mm) in silver RAL 9006 serve double-sided as sign panels. For mobile application we supply base plates (350 x 120 x 6 mm in RAL 9007), which are screwed edge to edge. The overall depth is 45 mm.



Sign size	Information area	Art. No.		
height x width x depth in mm	height x width in mm			
1800 x 450 x 45	1795,5 x 445,5	i 25stele1800.450		
2000 x 600 x 45	1995,5 x 595,5	i 25stele2000.600		
2000 x 730 x 45	1995,5 x 725,5	i 25stele2000.730		

\* We require a scale assembly drawing of the proposed free standing. Please note that the door signs/directories must be capable of being opened towards the side or the top to enable the sign information to be changed.

Special sizes on request.

## Madrid Information stand

The latest trend – the mobile information stand "Madrid" combines functionality with aesthetics and thus draws attention to itself.

### Technical data:

The curved aluminium holder (silver) is fastened to the stand made of steel in the format 220 x 300 x 4 mm (painted in RAL 7021 black grey) at the height of 900 mm. Exchangeable modules in varying formats can be stuck on and provide space for varying information.



### Infostativ

Information stand		Art. No.	
height in mm			
900 mm	silver RAL 9006 / gray RAL 7021	i stativ	

### Exchangeable module

Sign size		Information area	Art. No.	
height x width in mm		height x width in mm		
299,5 x 212,5	DIN A4 portrait	293 x 206	i 2504goa*	
212,5 x 299,5	DIN A4 landscape	206 x 293	i 2514goa*	
422,5 x 299,5	DIN A3 portrait	416 x 293	i 2503goa*	
299,5 x 422,5	DIN A3 landscape	293 x 416	i 2513goa*	

\* The back panel on the exchanger modules do not have any holes. A double-sided adhesive tape for sticking in place is included (for retrofitting).

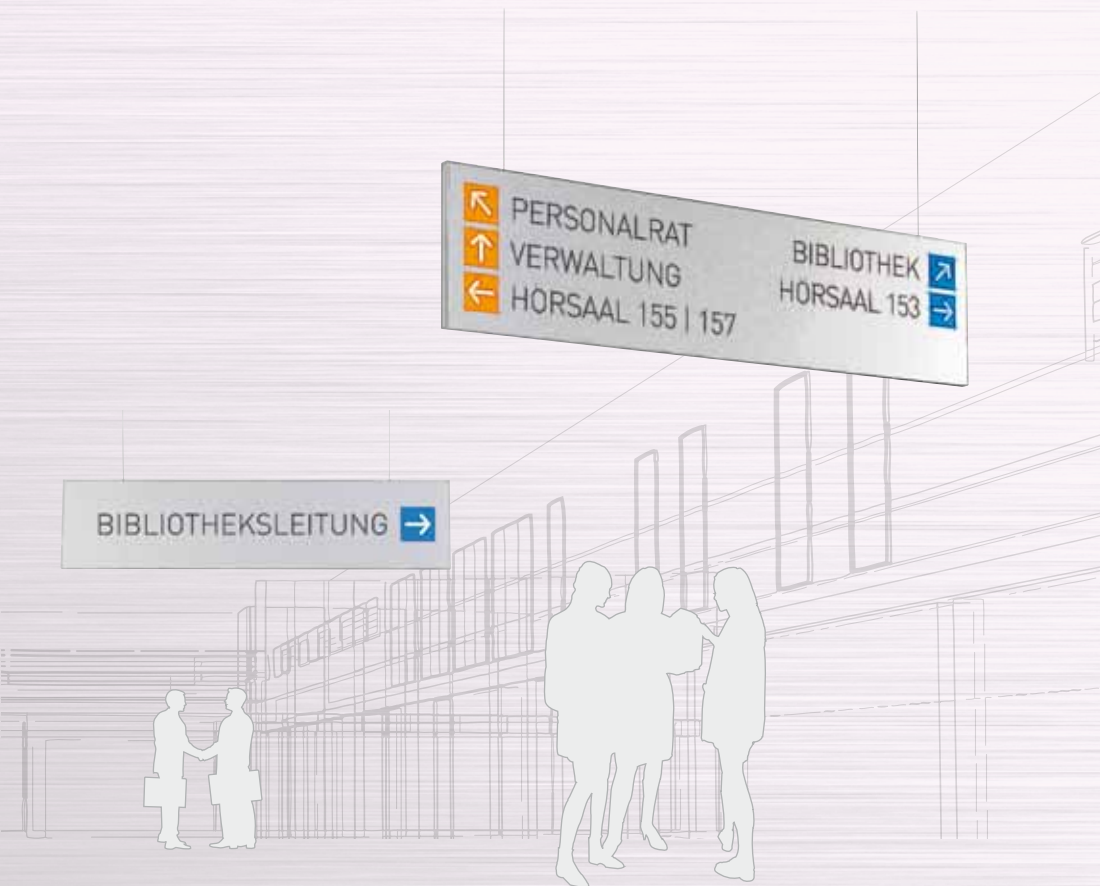

The sign information is applied directly to the area for information using self-adhesive foil letters, digital printing or Emergency / Fire safety symbols.

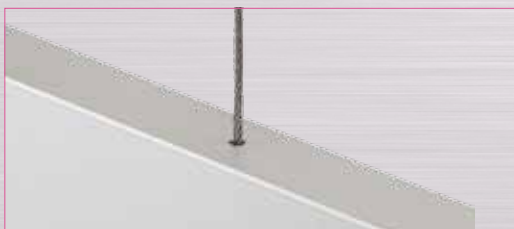

#### Technical data:

The base panel is comprised of a surrounding silver anodized aluminium frame with angle brackets inside, covered on both sides with aluminium composite panels (3 mm) in silver RAL 9006. The overall depth is 16 mm. Delivery includes two 1.5 m steel cords and press-on lugs.

## Madrid Directory for suspending from the ceiling - non paperflexible

Sign size	Information area	Art. No.
height x width x depth in mm	height x width in mm	
150 x 650 x 16	147,5 x 647,5	i 25hänger150.650
150 x 850 x 16	147,5 x 847,5	i 25hänger150.850
150 x 1000 x 16	147,5 x 997,5	i 25hänger150.1000
150 x 1250 x 16	147,5 x 1247,5	i 25hänger150.1250
250 x 650 x 16	247,5 x 647,5	i 25hänger250.650
250 x 850 x 16	247,5 x 847,5	i 25hänger250.850
250 x 1000 x 16	247,5 x 997,5	i 25hänger250.1000
250 x 1250 x 16	247,5 x 1247,5	i 25hänger250.1250

Accessories	Art. No.
Automatic unit	(instead of hooks) i 7732 *

\* Two automatic units are required per sign. The automatic unit is described on page 93.

Special sizes on request.

### Installation and sign information

The sign can be fastened to the ceiling either with conventional hooks or an automatic ceiling fastening system. The automatic device permits the sign to be adjusted retroactively so that if it is not straight or there are any differences in the length of the cord, these can be corrected with ease.

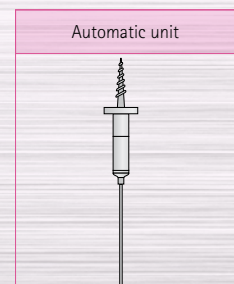
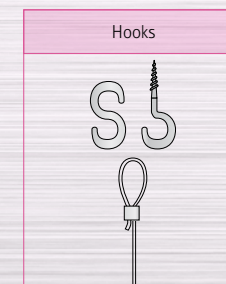
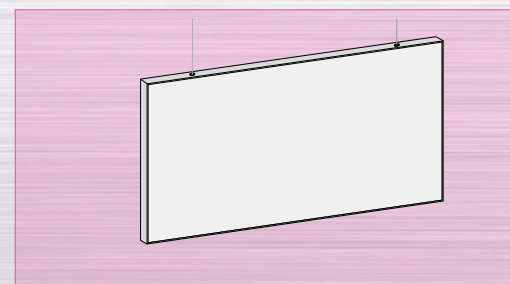



## Madrid Directory for suspending from the ceiling - paperflexible

For sign information on both sides (e.g. with safety symbols or paper inlays), including two 1.5 m steel cords and press-on lugs.



Sign size	Information area	Art. No.	
height x width in mm	height x width in mm		
150,5 x 299,5	144 x 293	i 2540	

Accessories		Art. No.	
Automatic unit	(instead of hooks)	i 7732 *	

\* Two automatic units are required per sign. The automatic unit is described on page 93.

### Installation and sign information

The sign can be fastened to the ceiling either with conventional hooks or an automatic ceiling fastening system. The automatic device permits the sign to be adjusted retroactively so that if it is not straight or there are any differences in the length of the cord, these can be corrected with ease.

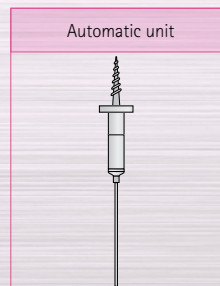
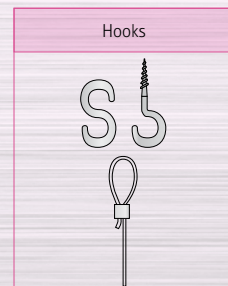
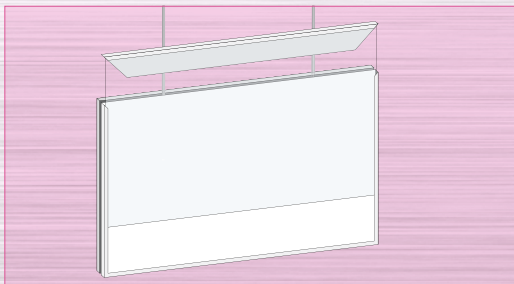

## Madrid Directory for projecting

For sign information on both sides (e.g. with safety symbols or paper inlays).



Sign size	Information area	Art. No.	
height x width in mm	height x width in mm		
150,5 x 150,5	144 x 144	i 2551	
150,5 x 299,5	144 x 293	i 2550	
212,5 x 299,5	206 x 293	i 2554	
299,5 x 422,5	293 x 416	i 2553	

### Description and installation

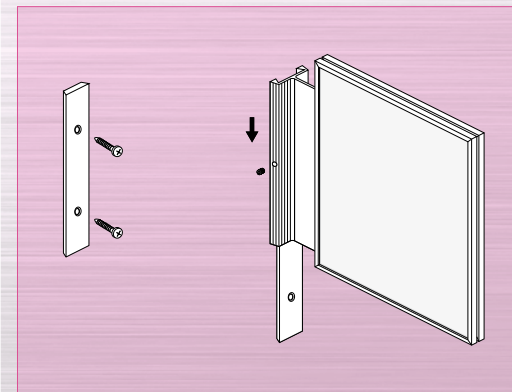

The adapter consists of a mounting base profile and an adapter profile in anodized silver. The base profile is attached to the wall using two screws\*. A grub screw at the side secures the slid over adapter, on which the signs are attached on both sides.

\* Assembly material for wall mounting (screws and dowels) not included in delivery.

## Madrid Door Sign / Directory for wall mounting



Silver anodized aluminium frame  
Back panel silver, with holes

Paper inlay

Non-reflective cover

! In order to prevent unauthorized access you can find our anti-theft device on page 67.

### Installation

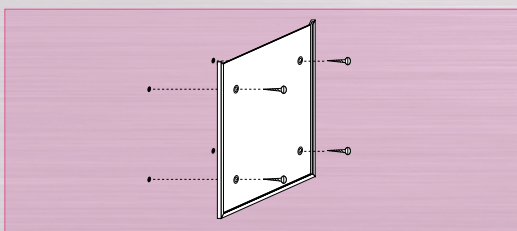

The door sign or the directory is mounted to the wall by four screws\*.

\* Assembly material for wall mounting (screws and dowels) not included in delivery.

Sign size *		Information area	Art. No.		
height x width in mm		height x width in mm			
75,5 x 150,5	Door sign 75	69 x 144	i 2501		
150,5 x 105,5	DIN A6 portrait	144 x 99	i 2506		
105,5 x 150,5	DIN A6 landscape	99 x 144	i 2516		
120,5 x 120,5	Door sign 120	114 x 114	i 2520		
150,5 x 150,5	Door sign 150	144 x 144	i 2500		
212,5 x 150,5	DIN A5 portrait	206 x 144	i 2505		
150,5 x 212,5	DIN A5 landscape	144 x 206	i 2515		
182,5 x 182,5	Door sign 182	176 x 176	i 2518		
299,5 x 150,5	Safety sign portrait	293 x 144	i 2531		
150,5 x 299,5	Safety sign landscape	144 x 293	i 2530		
299,5 x 212,5	DIN A4 portrait	293 x 206	i 2504		
212,5 x 299,5	DIN A4 landscape	206 x 293	i 2514		
299,5 x 299,5	Directory 299	293 x 293	i 2529		
422,5 x 299,5	DIN A3 portrait	416 x 293	i 2503		
299,5 x 422,5	DIN A3 landscape	293 x 416	i 2513		
596,5 x 422,5	DIN A2 portrait	590 x 416	i 2502		
422,5 x 596,5	DIN A2 landscape	416 x 590	i 2512		
844,5 x 596,5	DIN A1 portrait	838 x 590	i 2507		
596,5 x 844,5	DIN A1 landscape	590 x 838	i 2517		
1192,5 x 844,5	DIN A0 portrait	1186 x 838	i 2509		
844,5 x 1192,5	DIN A0 landscape	838 x 1186	i 2519		

\* Indicated sign sizes "height x width" means that opening is upwards.



## Madrid Main Directory / Outdoor sign for wall mounting

The Madrid main directory permits individual combinations of different sizes and types of sign. It comes in a slim-line and elegant design for the display of information on large surfaces. The sign information can be applied directly to the base panel, and for the quick exchange of information, exchanger modules offer the ideal solution.

To be able to produce the Madrid main directory we require a scale assembly drawing of the proposed guide. Please note that the door signs/directories must be capable of being opened towards the side or the top to enable the sign information to be changed.

### Technical data:

The basic structure is comprised of a surrounding silver anodized aluminium frame with angle brackets inside. It has keyholes on the back for wall mounting. The information panel itself is a 3.0 mm composite panel in silver RAL 9006 at the front. The overall depth is 16 mm.



On request the information signs can be supplied with concealed anti-removal guards.

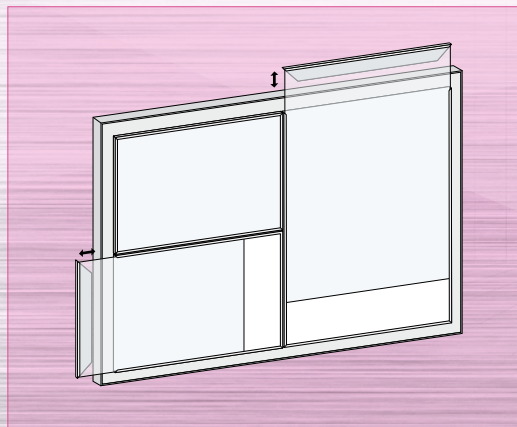
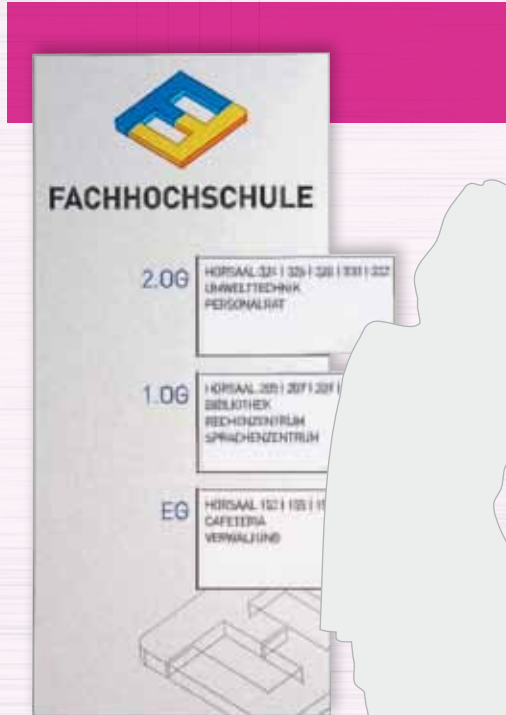

## Design example for main directory

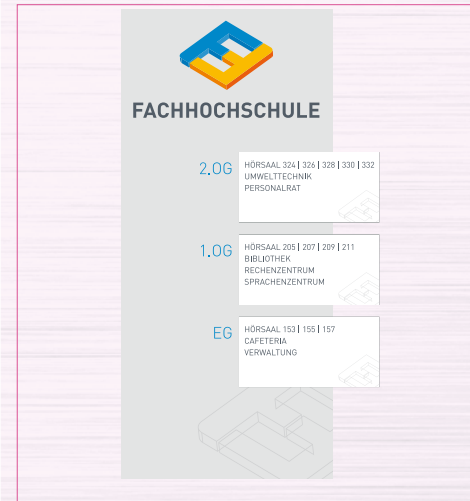

The above design example is comprised of the following:  
 1 x base panel size 450 x 1000 mm (i 25wand450.1000)  
 3 x Madrid directory size 150,5 x 299,5 mm (i 2531)

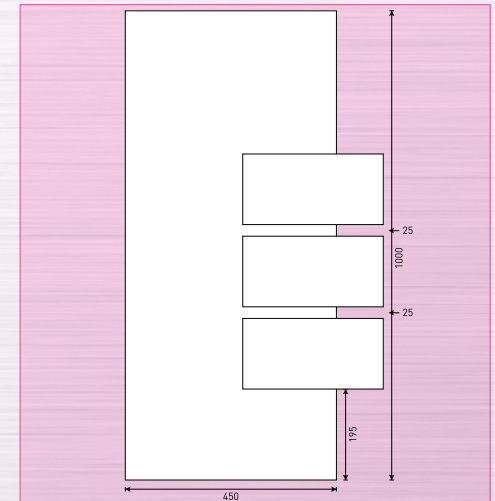

We require a scale assembly drawing of the proposed free standing. Please note that the door signs/directories must be capable of being opened towards the side or the top to enable the sign information to be changed.

## Installation of the main directory / outdoor sign

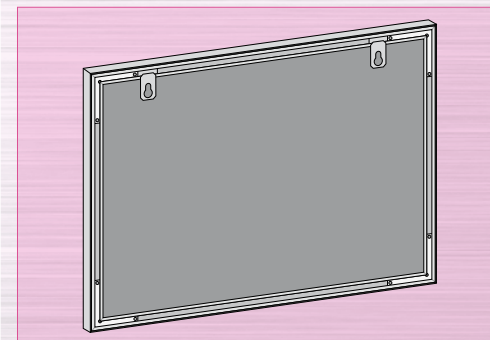

- 1 The unit is installed by screwing two screws\* to the wall through the keyholes. The sign is then hung on the screws.
- 2 The optional available locking device is installed by mounting the screw right in the centre of the frame (9,5 mm from bottom edge).
- 3 After the sign is hung the screw locking device is tightened with the special key.

\* Assembly material for wall mounting (screws and dowels) not included in delivery.

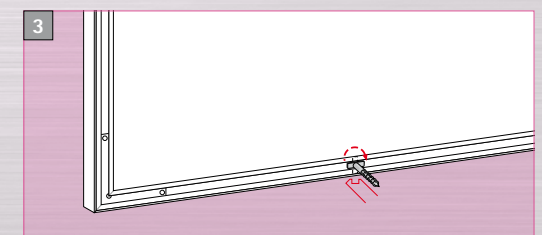
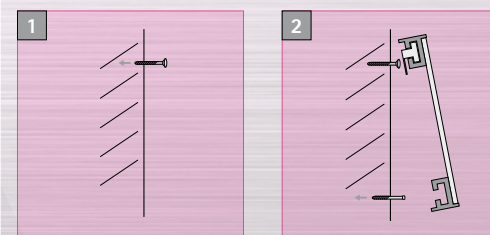

## Madrid Main Directory / Outdoor sign for wall mounting

Sign size	Information area	Art. No.		
height x width x depth in mm	height x width in mm			
450 x 450 x 16	447,5 x 447,5	i 25wand450.450		
450 x 650 x 16	447,5 x 647,5	i 25wand450.650		
450 x 850 x 16	447,5 x 847,5	i 25wand450.850		
450 x 1000 x 16	447,5 x 997,5	i 25wand450.1000		
450 x 1250 x 16	447,5 x 1247,5	i 25wand450.1250		
650 x 450 x 16	647,5 x 447,5	i 25wand650.450		
650 x 650 x 16	647,5 x 647,5	i 25wand650.650		
650 x 850 x 16	647,5 x 847,5	i 25wand650.850		
650 x 1000 x 16	647,5 x 997,5	i 25wand650.1000		
650 x 1250 x 16	647,5 x 1247,5	i 25wand650.1250		
850 x 450 x 16	847,5 x 447,5	i 25wand850.450		
850 x 650 x 16	847,5 x 647,5	i 25wand850.650		
850 x 850 x 16	847,5 x 847,5	i 25wand850.850		
850 x 1000 x 16	847,5 x 997,5	i 25wand850.1000		
850 x 1250 x 16	847,5 x 1247,5	i 25wand850.1250		
1000 x 450 x 16	997,5 x 447,5	i 25wand1000.450		
1000 x 650 x 16	997,5 x 647,5	i 25wand1000.650		

Sign size	Information area	Art. No.		
height x width x depth in mm	height x width in mm			
1000 x 850 x 16	997,5 x 847,5	i 25wand1000.850		
1000 x 1000 x 16	997,5 x 997,5	i 25wand1000.1000		
1000 x 1250 x 16	997,5 x 1247,5	i 25wand1000.1250		
1250 x 450 x 16	1247,5 x 447,5	i 25wand1250.450		
1250 x 650 x 16	1247,5 x 647,5	i 25wand1250.650		
1250 x 850 x 16	1247,5 x 847,5	i 25wand1250.850		
1250 x 1000 x 16	1247,5 x 997,5	i 25wand1250.1000		
1250 x 1250 x 16	1247,5 x 1247,5	i 25wand1250.1250		



## Accessories

special screw locking device  
key for locking device



## Art. No.

i wandschloss  
i wandschlüssel

Special sizes on request.



## Madrid Table-top sign

mounted on an aluminium angle.



Sign size	Information area	Art. No.
height x width in mm	height x width in mm	
75,5 x 150,5	69 x 144	i 2510

## Universal display „free | engaged“



Multitalent & all-rounder - the universal free | engaged display can be used in various situations: on flat or convex signs (in all formats), on table displays, confidentiality displays or simply directly on the door.

### Technical data:

The main body is made of transparent PMMA (format 46 x 46 x 5 mm). Switching between "free" or "engaged" is a simple matter of turning over the red or green surface. Delivery includes adhesive dots.

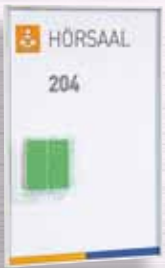

Name	Art. No.
Universal display free   engaged	i universalfb

## Madrid Paper inlays, sign information and accessories

Paper inlays *		Art. No.	Art. No.	UP
Format height x width in mm		pure white	silver	
72,5 x 147,5	for Door sign 75	i 2501-100P **		10 items
		i 2501-OP **	i 2501 - OSP **	50 items
117,5 x 117,5	for Door sign 120	i 2520-100P **		10 items
		i 2520-OP **	i 2520 - OSP **	50 items
147,5 x 102,5	for Door sign DIN A6	i 2506-100P **		10 items
		i 2506-OP **	i 2506 - OSP **	50 items
147,5 x 147,5	for Door sign 150	i 2500-100P **		10 items
		i 2500-OP **	i 2500 - OSP **	50 items
209,5 x 147,5	for DIN A5	i 2505-100P **		10 items
		i 2505-OP **	i 2505 - OSP **	50 items
247,5 x 296,5	for Safety signs	i 2530-100P **	i 2530 - OSP **	10 items
179,5 x 179,5	for Door sign 182	i 2518-10P **		10 items
		i 2518-OP **	i 2518 - OSP **	50 items
296,5 x 209,5	for DIN A4	i 2504-OP	i 2504 - OSP	10 items
296,5 x 296,5	for Directory 299	i 2529-OP	i 2529 - OSP	10 items
419,5 x 296,5	for DIN A3	i 2503-OP	i 2503 - OSP	10 items

\* Paper inlays are supplied in pure white or silver, blank for self-printing with laser or inkjet printers.

\*\* Punched on DIN A4 sheet.

Accessories / Pictograms	Dim. in mm	Art. No.
Design templates incl. Pictograms and free installation file „Inkscape“		i vorlagen
Pictograms, design Otl Aicher, single-color on white paper	147,5 x 147,5	
Emergency / Fire safety symbols (Laser-printed on white paper)	147,5 x 147,5	
	147,5 x 296,5	
Emergency / Fire safety symbols, photoluminescent	147,5 x 147,5	
	147,5 x 296,5	



Extract from a wide range. For further Otl Aicher pictograms, please refer to page 94 onwards. For a selection of Emergency / Fire safety symbols, please refer to www.moedel.de. For sign information in Braille / tactile lettering, please refer to page 92 onwards.



## Inserting the sign information

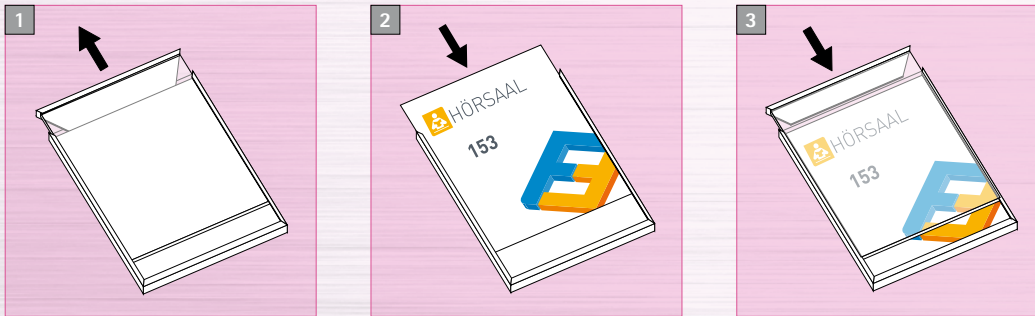

Pull the upper frame edge out of the base panel.  
Then insert and position the paper inlay.  
Slide the frame edge removed in step 1 back into the base panel.

## Locking Device

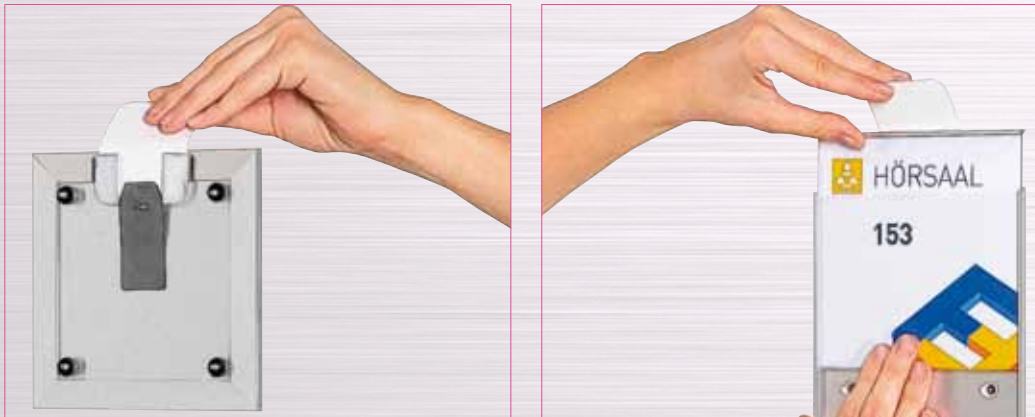

Accessories	Art. No.		
Set of locking device	i 25schloss *		
Special key for locking device (incl. Mounting instructions)	i 25schlüssel		

\* Non-visible locking device for retrofitting, adapted to all paperfixable wall signs and directories. The signs obtain a wall distance of 2,5 mm (shadow gap). A mounting instruction is included. A change of paper inserts or dismantling can only be done by opening the signs with a special key. Please order the needed number of keys separately!







Schilderfabrikation Moedel GmbH

➔ Warnen-Sichern-Kennzeichen

➔ Digitaldruck - Siebdruck

Werk I

August-Borsig-Straße 1

Industriegebiet Nord

D-92224 Amberg

➔ Leit- und Orientierungssysteme

Werk II

Wernher-von-Braun-Straße 13

Industriegebiet Nord

D-92224 Amberg

Postfach 1755

D-92207 Amberg

Telefon +49/9621/605-0

Telefax +49/9621/605-145

E-Mail [amberg@moedel.de](mailto:amberg@moedel.de)

Web [www.moedel.de](http://www.moedel.de)

Niederlassung Berlin

Danziger Straße 64

10435 Berlin

Telefon +49/30/44 34 09 56

Telefax +49/30/44 34 09 57

E-Mail [berlin@moedel.de](mailto:berlin@moedel.de)